

# Super Soft

by Kinetico

## Installation Instructions and User Manual



# Thank you for choosing a **SuperSoft** by Kinetico to improve the quality of your water.

There are two SuperSoft Water Softener models. Correct application will ensure you enjoy the full benefits of the water softener. If you are unsure of the correct model for your particular system, please contact your local stockist.

The High Efficiency SuperSoft (HE) is designed for vented systems (e.g. gravity/loft tank).

The High Flow SuperSoft (HF) is designed for pressurised systems (e.g. combi/pressurised cylinder).

## **Boosted water system:**

It is recommended that the High Efficiency SuperSoft (HE) model is installed prior to a boosted water system. Alternatively, the High Flow SuperSoft (HF) should be installed after the system.

# Contents

Safety information	<b>04</b>
Getting to know the softener	<b>06</b>
Checklist	<b>07</b>
Installation instructions	<b>09</b>
Installation review	<b>11</b>
Startup instructions	<b>12</b>
Maintaining your water softener	<b>13</b>
FAQs	<b>15</b>
Specifications	<b>16</b>

# Safety information

Read all information carefully prior to installing and using the water softener.

## Water Pressure

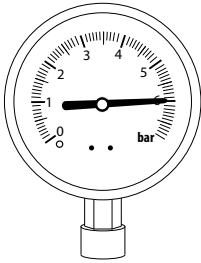

Do not install if the supply water pressure exceeds 6 BAR (87 psi), unless a suitable pressure regulating valve has been installed.

## Water Temperature

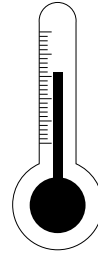

Do not install in an area where the water temperature can exceed 35°C or cause the unit to freeze.

## Overflow

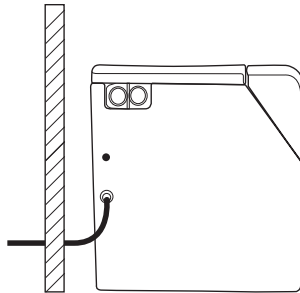

**VERY IMPORTANT:**

You must install the 5/8" O.D overflow tubing to the barbed fitting on the back of the cabinet and run to a suitable position that is visible and capable of taking water away from the unit (i.e. though an outside wall). The tubing **MUST** remain lower than the barbed fitting and must **NOT** be connected to a drain.

## Copper/Plastic Pipework

---

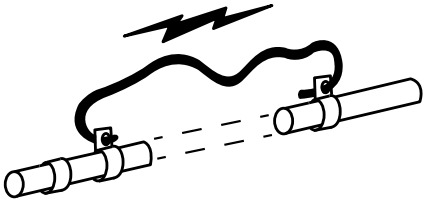

Where copper and plastic pipework is used, Kinetico advises adherence to the regulatory requirements to ensure adequate earth bonding is provided.

## Intended Use

---

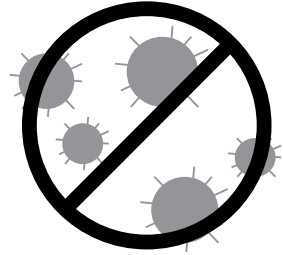

Not intended to be used for treating water that is micro-biologically unsafe or water that has an unknown quality, without adequate disinfection before or after the system.

# Getting to know the Softener

Take a look at the images below:

Side view:

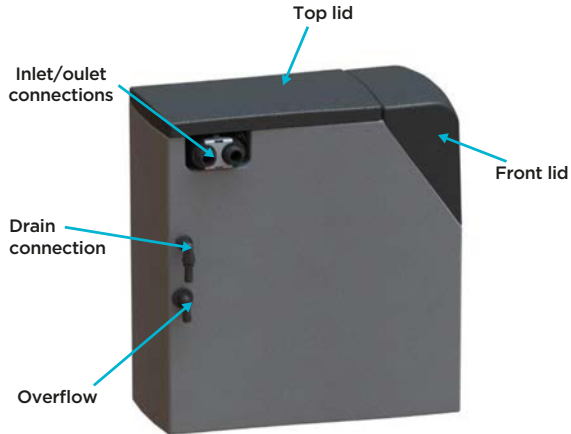

Birds eye view:

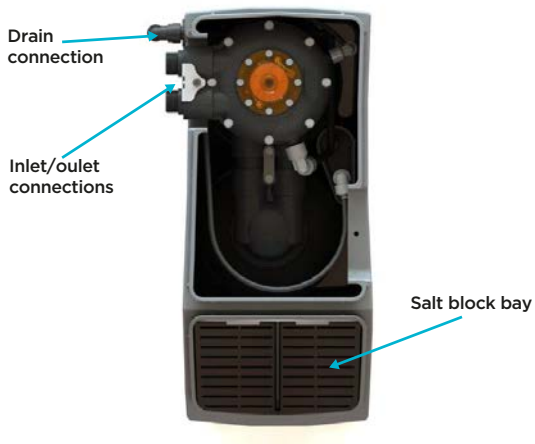



### Overflow, air gap and drain:

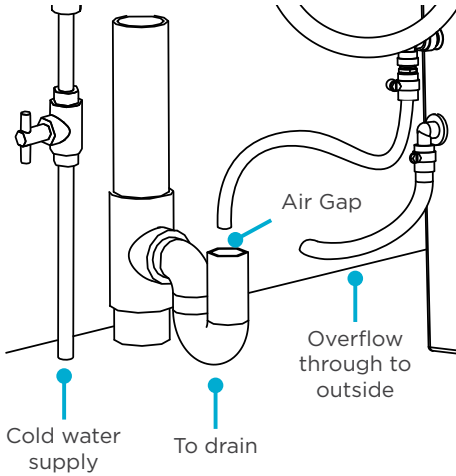

### Supplying a reverse osmosis drinking water filter:

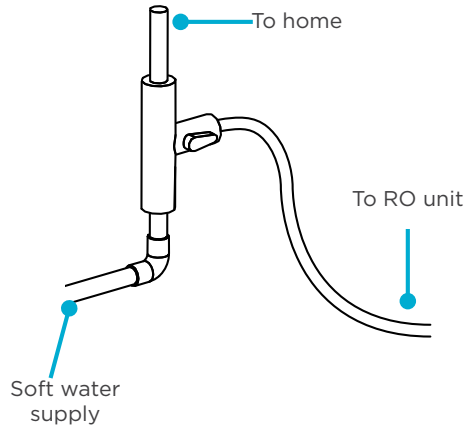

### By-pass:

By-pass assembly with non-return valve/check valve on inlet

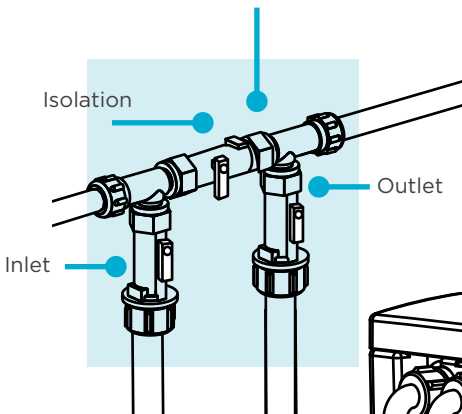

### Supplying a drinking water filter:

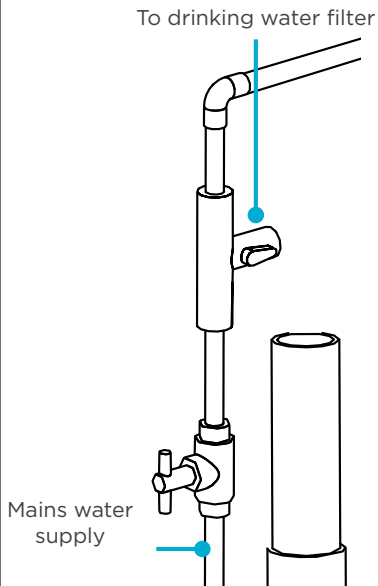



# Installation Instructions

## 1 Locate:

- a: Ensure the unit can be positioned on a flat surface.
- b: If sand, silt or turbidity is present in the water supply, a separate prefilter should be installed before the water softener.

### Please note:

The softener can be installed with the connections on the left or right side of the cabinet by reversing the components.



## 2 Test water pressure:

Test incoming pressure to the unit. A pressure regulating valve will be required if the pressure is above 6 bar.

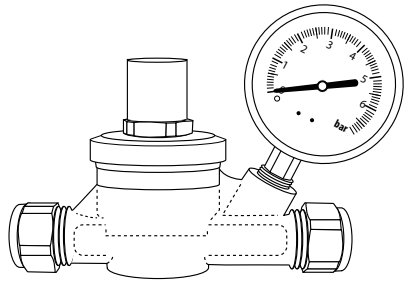

### 3 Install:

Plumb pipework as necessary to accommodate a by-pass assembly.

#### CAUTION:

Do not solder any fitting whilst connected to the unit adaptors. Excessive heat may result in damage to the plastic and rubber parts. The materials used in the soldering process may attack certain types of plastics. Care should be taken during the installation process to assure that solder and flux do not come in contact with media tanks, the control module and related plastic components.

#### NOTE:

Verify installation complies with local plumbing codes before continuing.

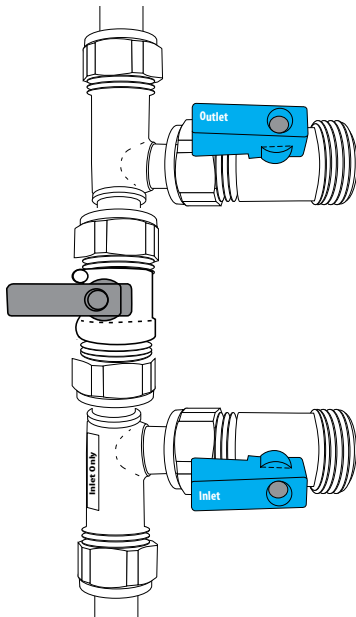

### 4 Flush:

After all the plumbing has been completed, but before connecting the water softener, flush both inlet and outlet lines allowing water to rinse out any debris in the lines.

### 5 Fit in/out adapters:

- a:** Fit 2 o-rings to each in/out adaptor then lubricate with the supplied silicone grease.
- b:** Connect the inlet/outlet adaptors to the supply and return hoses remembering to use the screened washers.
- c:** Install adapters into control valve in/out ports, ensuring that they are fitted into the correct ports (see flow arrows on valve for reference).
- d:** Attach the retaining bracket and pin to the control valve.



## 6 Run drain line:

- a:** Run a drain line to a discharge point, checking for any obstructions or possible kinks. FOLLOW REGIONAL WATER REGULATIONS.
- b:** Attach the drain elbow to the drain hose.
- c:** Attach the drain elbow to the module on the system.

### NOTE:

All connections are push-fit collets, please ensure they are firmly pushed into place.

Drain lines must not run more than 2.4m up or exceed a total of 9m. The drain line must not be restricted or kinked.



## 7 Attach overflow:

Attach 5/8" overflow tubing to barbed overflow connection at rear of cabinet and route to overflow outlet.

**IMPORTANT:** Do not connect the drain and overflow together.

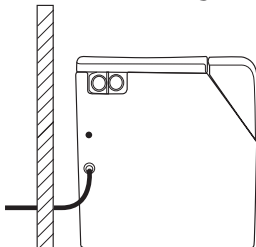

## 1 Test pressure:

Test incoming pressure and adjust valve if pressure is above 5 bar.

## 2 Secure drain line:

Make sure the drain line is secure, uses an airgap and is fully compliant.

## 3 Main inlet valve:

With the by-pass in position (inlet closed, outlet closed, by-pass open), turn on the main inlet valve slowly and check for leaks in the plumbing.

## 4 Pressurising:

With the inlet valve open, allow the softener to pressurise. Water may run to drain until fully pressurised.

## 5 Brine drum:

Allow the brine drum to fill with water until the brine valve shuts off. The water level should be approximately one inch over the grid plate. Ensure the brine valve is touching the base of the cabinet and the float cup is pushed all the way down.

## 6 Secure drain line:

Ensure all brine valve push fit connections are firmly pushed in and secured.

**TIP:** If cabinet does not fill with water, manually fill with 4 litres of mains water.

# Startup Instructions

## 1 Initiate a backwash:

- a: Ensure the unit can be positioned on a flat surface.

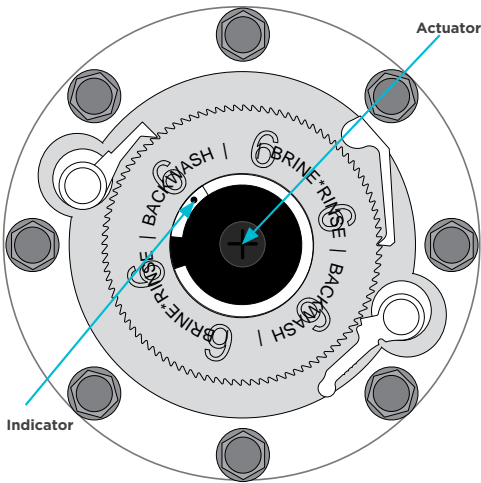

- b: You will hear a rush of water and air going to the drain.
- c: When the cycle has finished (approx 4 min), repeat the procedure, turn the indicator dot to the next backwash cycle and allow to finish (approx 4 mins).

### Note:

After the unit is pressurised, open the outlet valve, ensure isolation valve is closed. Open a tap in the house to release trapped air from the lines.

# Maintaining your water softener

---

The SuperSoft provides you with quality water without requiring extensive maintenance. Minor, routine maintenance is necessary to keep your softener working properly. Should you have any questions or need any assistance, contact your local stockist.

## 1 Adding salt:

---

The SuperSoft is designed to accommodate two 4kg blocks of salt in the front compartment although a good quality tablet salt can be used if desired.

The water level will normally sit around 5cm above the salt grid and in contact with the salt. It is normal for one block to dissolve quicker than the other.

### **IMPORTANT:**

Never use rock or granular salt in your system. It contains impurities that can interfere with performance.

## 2 Manual regeneration:

---

If your salt storage tank does run out, you will need to add salt then manually regenerate your water softener.

Please note, you should wait at least 3 hours after adding the salt before you regenerate the unit. If you prefer, you can wait for the system to automatically regenerate, although you may have hard water in the meantime.

To manually regenerate your system, using a Phillips head screwdriver, push down on the actuator and slowly turn CLOCKWISE until the actuator has advanced the indicator dot to the "BRINE" position.

You should hear at least 5 "clicks" while turning the actuator before the indicator dot reaches the "BRINE" position. At this point you will hear water flowing to the drain. This indicates that you have successfully initiated a regeneration. Repeat the procedure for manual regeneration after the water flow stops (approximately 11 minutes) to be sure both resin tanks are regenerated.

### **NOTE:**

If you do not hear a flow of water running to drain, please contact your local stockist.

### **NOTE:**

If your hot water tank or loft storage tank has filled with hard water, it may take several days for it to empty completely and for your water to feel soft again.

### **IMPORTANT:**

Never turn the actuator anti-clockwise.

### 3 Cold weather protection:

If your SuperSoft is installed outside or in an area that is not heated, you may want to take precautionary measures to prevent damage to your unit from freezing.

Kinetico offer cabinets specifically designed to protect your softener from freezing temperatures. Please call your local dealer for more information.

**NOTE:**

The warranty does not cover damage caused to your system due to freezing. If you have any questions about your SuperSoft, or you suspect that your system isn't working properly, contact your local stockist.

### 4 By-pass:

There may be times when you need to shut off the water supply to your entire house.

To do this, set the by-pass valve to the "OFF" position.

No water will flow through the house.

To restart the water, set the by-pass valve to the "SERVICE" position.

You may put the softener into by-pass at any time, if necessary, by putting the by-pass valve into the "BY-PASS" position. You will still get water throughout the house, however all of the water will be untreated.

To return the softener to service, set the by-pass valve to the "SERVICE" position.

**NOTE:**

By-pass styles vary and yours may not be as described. Contact your local stockist for further assistance.

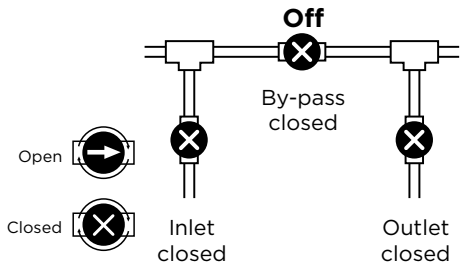
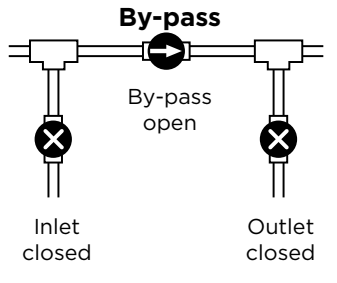
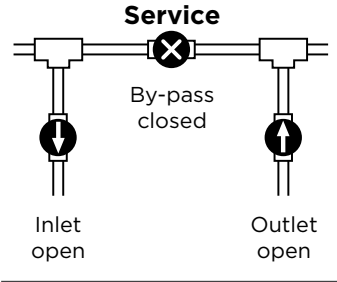

# FAQs

---

## **My system seems to be regenerating more frequently, is this normal?**

Your SuperSoft is demand operated and therefore adjusts to your water usage. If you do not think that your water usage has increased due to extra house guests, additional laundry or for any other reason, check for leaking plumbing, dripping taps or running toilets, all of which can contribute to more frequent regenerations.

## **My water doesn't seem soft. How can I be sure that my system is regenerating properly?**

Be sure that the water supply to the softener is not by-passed. Follow the instructions on page 12 to manually regenerate the softener. If the unit does not begin advancing to the next regeneration automatically, please contact your local stockist for further assistance.

## **I can hear my SuperSoft system running or regenerating during the day. My old softener only used to run at night. Is this normal?**

Single tank, electric water softeners tend to be set to regenerate at night because of the unavailability of soft water during the regeneration process. Unlike traditional water softeners, this system will operate based on your water usage, without timers or electronics.

Your system regenerates whenever necessary, at any time of day. The twin cylinder design allows one tank to provide treated water while the other regenerates so you will never be without soft water.

If at any time you feel your SuperSoft requires a service, put the system in by-pass and call your local stockist.

# Specifications

Meter Disc	1	2	3	4	5	6	7	8
Max hardness (in mg/L)	63	125	186	246	305	362	419	474
Litres between regenerations	1961	980	654	490	392	327	280	245

<b>Media Tank Size</b>	6" x 13"
<b>Cabinet Dimensions @ base</b>	H 495mm x D 475mm x W 205mm
<b>Resin per tank</b>	4.5 litres
<b>Tank Freeboard</b>	Packed
<b>Salt used per cycle</b>	0.3 kg
<b>Regeneration Time</b>	12 minutes
<b>Minimum Flow</b>	HE = 0.25 l/m HF = 1.1 l/m
<b>Maximum Peak Flow</b>	HE = 35 l/m HF = 48 l/m
<b>Backwash Rate</b>	1.8 l/m
<b>Resin Type</b>	Fine mesh
<b>Pipe connections - in/out</b>	3/4"
<b>Min./Max. Operating Pressure</b>	12/120 PSI (0.83 BAR/8.3 BAR)
<b>Min./Max. Operating Temperature</b>	1.7°C - 35°C
<b>Minimum Operating Flow</b>	1.1 l/m
<b>Water used per cycle</b>	23 litres